

First Alert®

2087DF-BD / 2092DF-BD



First Alert®

MANUAL # M08-0279-005

www.FirstAlert.com

DIGITAL | WATERPROOF
FIRE SAFE WITH READY-SEAL™



BOLT DOWN



FIRE RESISTANT



WATERPROOF



MEDIA PROTECTION

MANUAL # M08-0279-005

INDEX

Overview of Your Safe 1

Opening Your Safe for the First Time 3

Test Locking System 4

Programming a Personal Passcode 6

Emergency Override Key / Battery Replacement 7

Additional Features 7

Use, Care and Maintenance 8

Consumer Affairs 10

Safe Identification Record 12

Limited Warranty 13

FOR YOUR PROTECTION

- ✓ Do not remove the serial number tag from the safe.
- ✓ Store emergency override keys away from safe, NEVER INSIDE.
- ✓ Record all safe identification numbers on Safe Identification Record on page 12.
- ✓ Save this manual and NEVER keep it inside the safe.

OVERVIEW OF YOUR SAFE

Congratulations!

Your new First Alert® Digital Waterproof Fire Safe with Ready-Seal™ will provide years of safe and secure protection for your valuables, important documents and other personal items. All First Alert® safes are designed and built using the highest manufacturing standards to ensure maximum user satisfaction under a variety of conditions. With proper care, your First Alert® safe will provide peace of mind for many years to come. US Patent No. D557,875, 7,350,470. Other patents pending.

PACKAGE CONTENTS



2 Emergency Override Keys

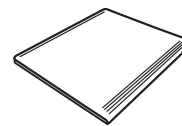

1 Adjustable Shelf

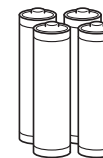

4 AA Batteries

READY-SEAL™ MOUNTING HARDWARE COMPONENTS



6 Flathead Cover Screws



1 Bolt Cover



1 Interior Fire/Water Gasket



1 Mounting Bolt with Flat Washer*



1 Upper Water Seal

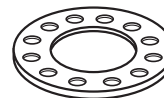

1 Exterior Fire/Water Gasket



1 Plastic Bottom Cover*



6 Flathead Bottom Cover Screws



6 Buttonhead Floor Mounting Bracket Screws*

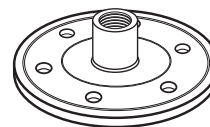

1 Floor Mounting Bracket

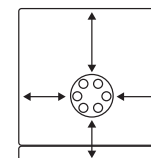

1 Ready-Seal™ Mounting Template*



1 Bolt Handle Tool*



1 Ready-Seal™ Mounting Instructions*

* Components packed separately in bag. All other components shipped attached to safe.

IMPORTANT: DO NOT RETURN SAFE TO STORE

If you are missing parts, have difficulty programming your safe or have any other questions pertaining to its proper use and care, DO NOT RETURN your safe to the store. Please contact Consumer Affairs at **1-800-323-9005, 7:30 a.m. – 5 p.m.** Central Standard Time, Monday through Friday. To assist us in serving you, please have the model number, serial number and date of purchase available when calling.

OPENING YOUR SAFE FOR THE FIRST TIME

IMPORTANT FIRST TIME ACTIVATION

Your safe is ready for activation. To open the safe and prevent it from locking before completing the first-time activation, a solenoid deactivation safety device has been installed.

BATTERIES AND EMERGENCY OVERRIDE KEYS

Remove four (4) AA batteries and two (2) Emergency Override Keys. They are located in the protective styrofoam insert at the top of the box.

USER ACTIVATION

Install Batteries

- 1 Turn handle upwards to the right and pull open the safe door. Note: This waterproof safe may require additional force upon initial entry.
- 2 Slide the battery compartment cover forward and remove. The compartment is located inside the safe at the top of the door. Install the four (4) AA batteries. Make sure the batteries are installed in the proper direction as indicated in the battery compartment. Slide the cover back into place.
- 3 After the batteries are correctly installed, the red and green lights located at the top of the keypad on the front of the safe will blink twice, the keypad backlight will flash once and you will hear a single beep.
- 4 Proceed to Activate Lock.

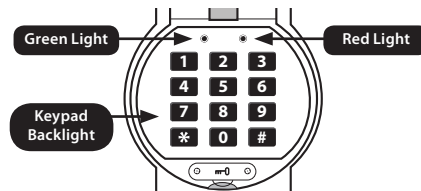
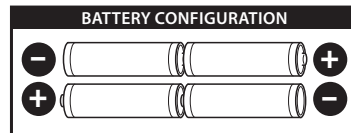
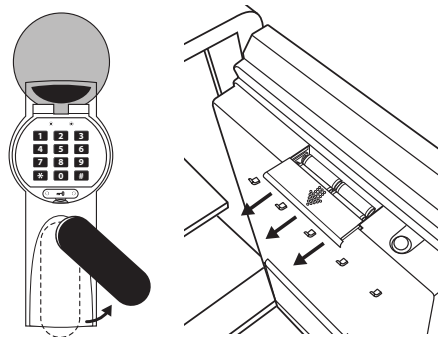

IMPORTANT ENABLE/DISABLE SOUND

Once the batteries are installed, if you do not hear a beep when entering the factory pre-set passcode or during the personal passcode re-programming process, enter the following key sequence into the digital keypad:



This will turn the sound on. Repeat the process if you want the sound turned off.

ACTIVATE LOCK

- 1 Locate the small plastic Locking Pin on the inside of the safe door. Grip and pull out completely then dispose of properly.
- 2 Leave the safe door open and proceed to Electronic Locking System Test.

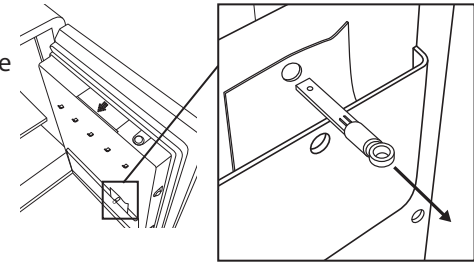

TEST LOCKING SYSTEM

ELECTRONIC LOCKING SYSTEM TEST

With the door still open, you can test the Electronic Digital Lock by manually activating the Locking System.

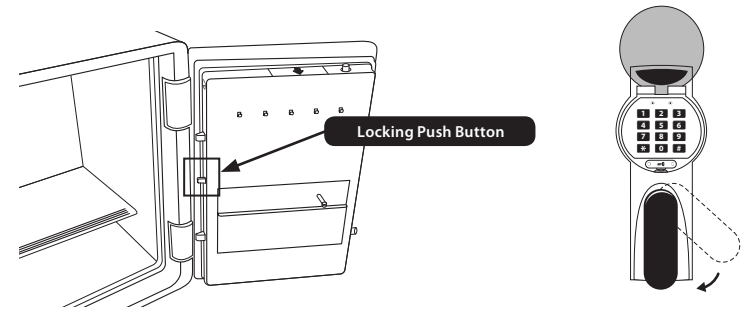

To activate the Locking System, locate the locking push button on the inside of the safe door, push it in and turn the handle to the left. This will cause the live door bolts to extend out and into the locked position. Now with the door open and the live door bolts in the locked position, you may proceed to Testing the Passcode.

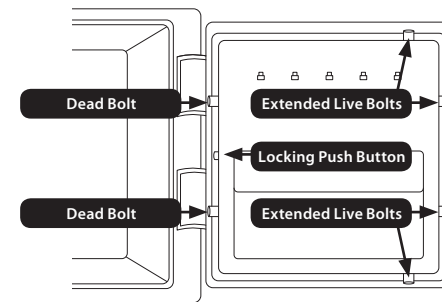

IMPORTANT ENGAGING LIVE BOLTS

Closing the safe door with the Live Bolts in the locked position can damage the safe. The locking push button should only be used when testing or programming the safe with the door remaining open.

TESTING THE PASSCODE

- 1 With the safe door open and the Live Bolts engaged, you can now test the Electronic Locking System using the pre-set three digit factory code. Locate the digital keypad on the front of the safe and open up the protective cover to expose the keypad.
- 2 When the cover is opened, the keypad is activated and the keypad backlight will turn on and remain on for approximately five (5) seconds. The keypad is still active even when the backlight turns off. It will turn on again when any key is pressed.
- 3 The pre-set three digit factory passcode is 159. Enter this passcode as follows:



NOTE: ALL ENTRIES ARE ACCOMPANIED BY A BEEP AND THE GREEN LIGHT WILL FLASH.

- 4 After properly entering the entire sequence, the green light will turn on and the lock will click. You now have five (5) seconds to open the safe by turning the safe door handle upward to the right.

IMPORTANT IF HANDLE WILL NOT TURN

If the handle will not turn to the right after the green light comes on, first turn the handle slightly back to the left until it stops, then turn upwards to the right again to open.

- 5 Once the handle has been turned to the right, the live bolts will disengage and retract into the door. At this point you have successfully unlocked the safe and the door can be opened. Note: This waterproof safe may require additional force upon initial entry.
- 6 Leave the safe door open and proceed to Programming a Personal Passcode.

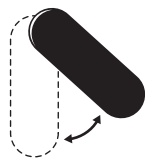

IMPORTANT SECURITY LOCKOUT PERIODS

For added security, the safe will automatically lock out entry for 15 minutes after three (3) attempts to open with an invalid passcode.



PROGRAMMING A PERSONAL PASSCODE

For security reasons, it is very important that you program your own personal passcode into the digital lock. The factory code should be changed immediately.

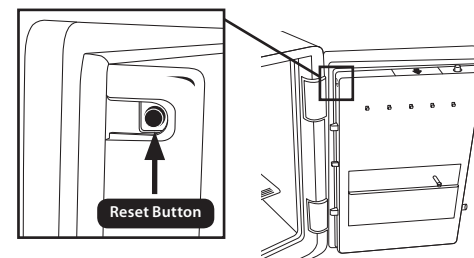

To program your own unique three to eight digit (3-8) passcode, follow these steps:

NOTE: AFTER PRESSING THE RESET BUTTON, THE RED AND GREEN LIGHTS ON THE KEYPAD WILL FLASH TO INDICATE THE PROGRAMMING IS AUTHORIZED AND YOU HAVE 10 SECONDS TO BEGIN.

- 1 Open the protective cover on the front of the safe to expose the keypad.
- 2 With the safe in the open position, press the small reset button located on the inside top edge of the door.
- 3 Enter your new three to eight digit (3-8) passcode followed by the # key.



Minimum 3 Digits

Immediately repeat the sequence, beginning with the new passcode followed by the # key.



- 4 The green light will light up solid for 5 seconds, indicating your new passcode has been successfully entered.
- 5 Your new passcode will now be comprised of the three to eight (3-8) digit sequence you selected, always followed by the # sign. The factory pre-set Passcode will no longer open the safe.
- 6 You may change your passcode at any time by repeating the same steps.
- 7 It is important that you write down your personal passcode and secure it in a safe location away from the safe.



NOTE: IF YOU FORGET YOUR PERSONAL PASSCODE, ACCESS TO THE SAFE CAN BE MADE USING THE EMERGENCY OVERRIDE KEY.

IMPORTANT ONCE YOUR PERSONAL PASSCODE IS PROGRAMMED, THE FACTORY PRE-SET CODE WILL NO LONGER OPEN THE SAFE.

EMERGENCY OVERRIDE KEY/BATTERY REPLACEMENT



- 1 Locate and open the protective keypad cover on the front of the safe.
- 2 Using a small Phillips head screwdriver, remove the two screws securing the small Emergency Override Key lock cover located just below the digital keypad. Pull forward on the cover to remove and set aside with the small screws.
- 3 Insert the Emergency Override Key into the lock and turn clockwise to the right.
- 4 Turn the handle upwards to the right to open the safe.

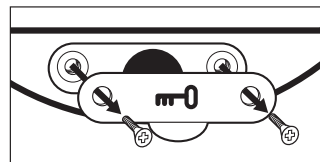

NOTE: IF BATTERIES NEED REPLACING, PROCEED WITH STEP 5. OTHERWISE, PROCEED TO STEPS 6-8.

- 5 Slide the battery compartment cover (located inside the safe at the top of the door) forward and remove. Remove and properly dispose of the four (4) nonworking batteries. Install four (4) new AA batteries. Make sure the batteries are installed in the proper direction as indicated in the battery compartment. Slide the cover back into place.
- 6 Remove the Emergency Override Key, and before replacing the lock cover, enter your personal passcode to make sure the safe will open.
- 7 Replace the lock cover using the two small screws and return the Emergency Override Key to a secure place away from the safe.
- 8 Close and lock the safe door by turning handle downward to the left.

ADDITIONAL FEATURES

SHELF

To allow for greater flexibility and further accommodate your particular storage needs, this safe includes one (1) adjustable/removable shelf.

- 1 Position shelf so that the gripping ridges are on the top and towards the front of the safe.
- 2 Locate the approximate position in the safe where you would like to place it and, using the guides molded into the walls of the safe, slide the shelf into place.



LOW BATTERY INDICATOR

Every time the keypad is activated, the system automatically checks the power level remaining in the batteries. If the power falls below a certain level, the red light will flash every two seconds to indicate the need for new batteries.

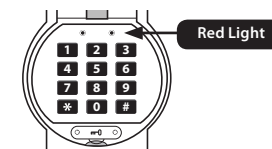

BOLTING DOWN YOUR SAFE

For added security your safe can be bolted to the floor. With Ready-Seal™ Technology you are able to bolt your Fire Safe to the floor without compromising the fire or water protection. Please refer to the separate *Ready-Seal™ Mounting Instructions* included in this package.

DISABLE / ENABLE SOUND

- 1 To enable (turn on) the sound during normal operation, press the following key sequence:
- 2 Repeat the process to turn the sound off.



USE, CARE AND MAINTENANCE

APPROPRIATE USE OF YOUR SAFE

First Alert® Waterproof and Fire Resistant Safes protect paper records and many other valuables.

Verified fire protection for:



CDs & DVDs

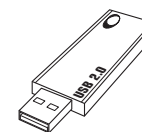

USB Drives



External Hard Drives

This product is **NOT INTENDED** to protect audio or video cassettes, floppy discs, data cartridges, film and photos or photo negatives from fire.

Testing shows that the interior temperature of the safe remains below 350°F for one (1) hour during a fire up to 1700°F when used properly. Your safe must be closed and latched in order to properly protect the contents from fire.





Moisture Warning

We recommend that you place delicate items such as pictures or intricate jewelry into an air-tight container before storing them in your safe. Avoid placing your safe in areas of high humidity. For optimum performance, the safe should be opened and aired out for at least 20 minutes every two (2) weeks.



Firearms Warning

This safe is not designed to store medication, items with combustible content, guns or other weapons.



Pearls

Because pearls sustain heat damage at temperatures below 350° F, we advise that you DO NOT store pearls in this fire safe.

SAFE CARE AND MAINTENANCE

When properly maintained, your safe will continue to operate accurately for many years. In order to ensure optimum performance of your safe, please follow these simple precautions:

Battery Maintenance

- 1 Always purchase and use the batteries as specified by this User's manual.
- 2 Always replace **all** batteries at the same time. It is recommended to replace all batteries at least once a year or sooner depending on amount of use.
- 3 Always clean the battery contacts in the battery compartment and on the batteries before installing new batteries.
- 4 Always make sure all batteries match the polarity (+ and -) signs in the open battery compartment.
- 5 If your safe will not be used for an extended period of time, it is recommended that you remove the batteries.
- 6 Always promptly remove and properly discard of all used batteries.

Clean Hands - Never attempt to operate the digital keypad if your hands have excessive dirt, debris or liquids on them.

Clean Safe – To clean the surface of your safe, it is recommended that you use a mild cleaner (e.g., window cleaner) to avoid scratching or discoloring the surface. Always wipe dry and NEVER use abrasive cleansers on the safe or digital keypad.

Waterproof – Your new First Alert® Digital Waterproof Fire Safe with Ready-Seal™ is designed to help protect your valuables from fire and water. This product has been validated to be waterproof when fully submerged for up to 1 hour and is not intended for long term underwater exposure.



For future reference, store this manual in a secure area away from the safe.
DO NOT DISCARD!

CONSUMER AFFAIRS

YOUR SAFE'S UNIQUE IDENTIFICATION NUMBERS

When contacting Consumer Affairs, you should be prepared to supply some important information that specifically identifies your safe. This information is extremely important to assuring prompt and accurate customer assistance.

It is strongly recommended that you identify and record the following information in the Safe Identification Record form located on page 12.

MODEL NUMBER

SERIAL NUMBER

KEY NUMBER

LOCATING MODEL AND SERIAL NUMBERS

Most First Alert® safes include a small metallic silver or gray tag affixed to one of the surfaces. This tag is usually located on the front or right side of the safe. This tag contains the serial number and on selected models a similar tag is attached containing the model number. If a model number tag is not attached to the safe, then it can be located on the front or side panel of the box that the safe was packaged in. Write this number down for future reference.

KEY NUMBER

The key number is located on the key. If you do not have the key, the number is also located on a sticker on the inside of the emergency override key lock cover.

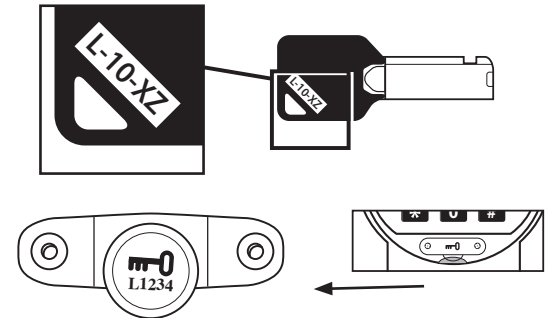

IMPORTANT DO NOT REMOVE TAGS

In case your safe becomes inoperable or you lose your keys, these identification numbers will be needed to correct the problem. It is recommended that the number tags remain in place on the safe. If removal is necessary, then they should be attached to the inside back cover of this manual. Store in a safe and secure place for future reference.

HOW TO OBTAIN WARRANTY SERVICE

If service is required, do not return the product to your retailer. In order to obtain warranty service, contact Consumer Affairs at 1-800-323-9005, 7:30 a.m. – 5 p.m. Central Standard Time, Monday through Friday. To assist us in serving you, please have the model number and date of purchase available when calling.

For Warranty Service return to:

**First Alert, Inc.
Attn: Warranty Safe Returns
23610 S Banning Blvd
Carson, CA 90745**



PLEASE CALL US AT 1-800-323-9005 TO ESTABLISH A WARRANTY RETURN SET-UP

ORDERING REPLACEMENT KEYS

If you lose the Emergency Override Keys or would like additional keys, you can purchase them from First Alert, Inc. You must supply the following information to assure accurate processing:

1. Name / Address / Telephone Number
2. Safe Model Number / Serial Number
3. Key Number (located on the key and on the Emergency Override Key Lock)
4. Notarized statement of ownership (a notary letter form can be printed off at www.firstalert.com)
5. Indicate number of keys requested

Please send all the information via fax at 630-851-7995 or mail First Alert, Inc., 3901 Liberty Street Road, Aurora, IL 60504-8122.

Checks or Money Orders are required for orders received by mail and should be made payable to First Alert. Contact our Consumer Affairs Department for costing information prior to ordering.

Mail To: First Alert, Inc.

**Attn: Consumer Affairs
3901 Liberty Street Road
Aurora, IL 60504-8122**

SAFE IDENTIFICATION RECORD



Model Number _____

Serial Number _____

Key Number _____

Digital Passcode Record _____

Your passcode must be at least three (3) digits and no more than eight (8) digits followed by the # sign.

LIMITED WARRANTY

LIFETIME AFTER FIRE REPLACEMENT GUARANTEE

If your First Alert® Digital Waterproof Fire Safe is ever damaged by a fire, BRK will replace it with a comparable model at no charge to the consumer. Freight on the replacement unit is not included in the guarantee and must be paid by the consumer.

For claims, submit your name and address, a photo of the damaged safe along with its Model Number, and a copy of the Fire Department report to BRK Consumer Affairs as proof of loss. Once the information is received, Consumer Affairs will contact you with further instructions.

LIMITED WARRANTY

BRK Brands, Inc., ("BRK") warrants that for a period of five (5) years from the date of purchase, this product will be free from defects in material and workmanship. BRK, at its sole option, will repair or replace this product or any component of the product found to be defective during the warranty period. Replacement or repair will be made with a new or remanufactured product or component.

If the product is no longer available, replacement may be made with a similar product of equal or greater value. This is your exclusive warranty.

This warranty is only valid for the original retail purchaser from the date of initial retail purchase and is not transferable. You must keep the original sales receipt. Proof of purchase is required to obtain warranty performance. BRK dealers, service centers, or retail stores selling this product do not have the right to alter, modify or in any way change the terms and conditions of this warranty.

This warranty does not apply to the finish on the product. This warranty does not cover normal wear and tear of parts or damage resulting from any of the following: negligent use or misuse of the product, use contrary to the operating instructions, disassembly, repair or alteration by anyone other than BRK or an authorized service center, improper installation, or exposure to extremes of heat or humidity. Further, the warranty does not cover Acts of God, such as fire, flood, hurricanes and tornadoes.

BRK shall not be liable for any incidental or consequential damages caused by the breach of any express or implied warranty. BRK is also not responsible for: costs associated with removing or installing the product; damage or loss of the contents of the product; nor for the unauthorized removal of the contents; or damages incurred during shipment. Except to the extent prohibited by applicable law, any implied warranty of merchantability or fitness for a particular purpose is limited in duration to the duration of the above Warranty Period.

Some states, provinces or jurisdictions do not allow the exclusion or limitation of incidental or consequential damages or limitations on how long an implied warranty lasts, so the above limitations or exclusion may not apply to you. This warranty gives you specific legal rights, and you may also have other rights that vary from state to state, or province to province, or jurisdiction to jurisdiction.

If you have any questions that cannot be answered by reading this manual, call Consumer Affairs at 1-800-323-9005.

© 2011 BRK Brands, Inc., a Jarden Corporation company (NYSE: JAH)
3901 Liberty Street Road, Aurora, IL 60504-8122
All rights reserved.
www.FirstAlert.com